

# User Manual

pE-100

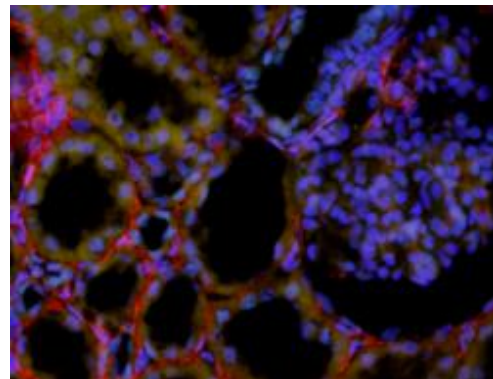

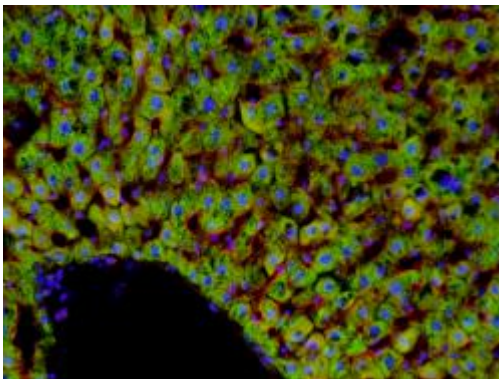
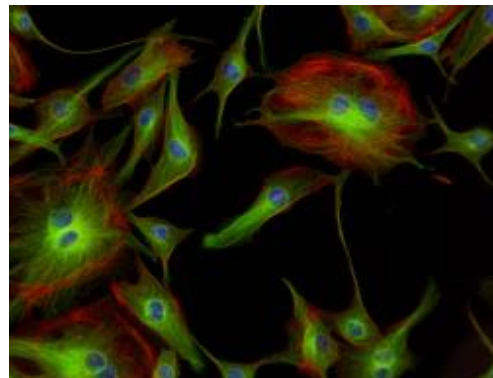
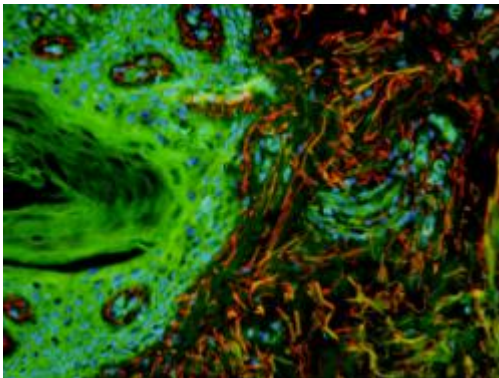
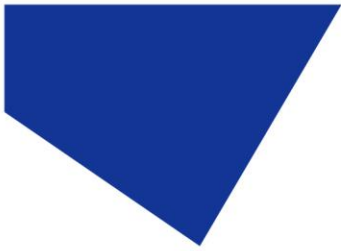

## Table of Contents

1.	Introduction.....	3
2.	Safety Precautions.....	4
3.	Getting Started – System Components.....	6
4.	Installation and Setup.....	7
5.	Operation - Manual Control.....	9
6.	Remote Operation – TTL.....	10
7.	Optical Setup.....	12
8.	Settings/Additional Information.....	13
9.	Routine Care and Maintenance.....	14
10.	Fitting the pE-100 to a Different Microscope.....	15
11.	pE-100 Liquid Light Guide Option.....	16
12.	Product Specifications.....	18
13.	Product Options and Order Codes.....	18
14.	Warranty and Repairs.....	19
15.	Compliance and Environmental.....	19
16.	Contact Details.....	20

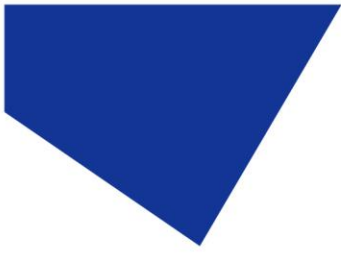

## 1. Introduction

CoolLED's pE-100 has been developed for applications requiring a single LED excitation wavelength. It is perfect for clinical applications such as routine screening (e.g. using Auramine for Tuberculosis), for research applications requiring precise intensity control and fast-switching, or for electrophysiology applications where light has to be delivered to a specific location. The user can select from 20 different LED wavelengths, ranging from the near-UV at 365 nm to the near-IR at 770 nm.

With a comprehensive range of microscope adaptors, the pE-100 can be fitted to most current and older microscopes. The result is a safe, convenient illumination system which will last for many years without any additional operating costs.

This manual should give you all the information required to install and operate your new illumination system.

Additional information can be found on our website at [www.cooled.com](http://www.cooled.com)

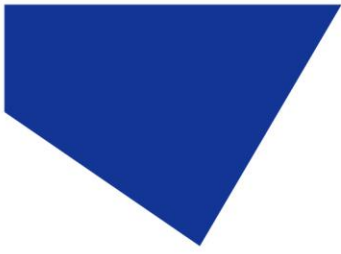

## 2. Safety Precautions

While LEDs are a much safer illumination system than the mercury and metal halide lamps that they replace in microscopy applications, precautions should still be taken with this product.

When operating or maintaining this product, please observe the following safety precautions at all times. Failure to do so may result in personal injury or damage to other items.

Please ensure that only the power supply and cord supplied are used with this equipment.

The AC cord supplied with this light source must only be used with the equipment supplied.

### 2.1.

UV light may be emitted from this product depending on the version/wavelength selected. Avoid eye and skin exposure. Never look directly into the light output beam from the Light Source or accessories. The emissions could damage the cornea and retina of the eye if the light is observed directly.

### 2.2.

Always ensure that the Light Source is securely attached to the microscope (either directly or with a light guide and collimator, depending on the version) prior to turning on the power. This will minimise the risk of injury and damage.

### 2.3.

If for any reason the Light Source is to be operated when not attached to a microscope, all personnel should wear eye shielding and clothing to protect the exposed skin.

### 2.4.

Disconnecting the mains supply is achieved by unplugging the power cord from the power supply block or the Light Source. Only plug in the power cable, once the Light Source is attached to the microscope.

### 2.5.

There are no serviceable parts within the Light Source. Removing any of the screws and covers will result in the safety of the Light Source being impaired. The DC power supply unit should be inspected periodically throughout the lifetime of the system.

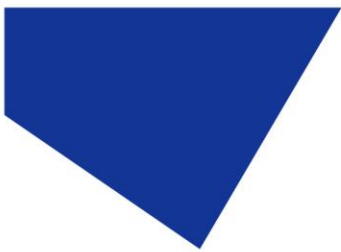

2.6.

Any electronic equipment connected to this product must comply with the requirements of EN/IEC 60950.

2.7.

To clean the exterior of the Light Source, use a slightly dampened cloth with a simple water/detergent solution only. Avoid the optical surfaces and lenses. Cleaning of optics should only be carried out using optical wipes and fluids. Please note that the DC power supply unit should be isolated prior to cleaning.

2.8.

This product conforms to the requirements of the Safety Standards as follows:

EN/IEC 61010-1:2010	Safety Requirements for Electrical Equipment for Measurement, Control and Laboratory use.
EN62471:2008	Photo-biological Safety of Lamps and Lamp Systems/Guidance on manufacturing requirements relating to non-laser optical radiation safety. Risk Group 3.

<b>RISK GROUP 3</b>
WARNING UV emitted from this product. Avoid eye and skin exposure to unshielded product.
WARNING Possibly hazardous optical radiation emitted from this product. Do not look at operating lamp. Eye injury may result.
CAUTION IR emitted from this product. Avoid eye exposure. Use appropriate shielding or eye protection

*All warnings may not be applicable depending on the version/wavelength being used.*

2.9. **EMC compliance**

This product is tested to the requirements of standard IEC/EN 61326-1 concerning electromagnetic compatibility. This is a Class A product. In a domestic environment this product may cause radio interference in which case the user may be required to take adequate measures.

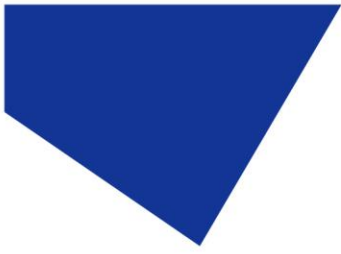

### 3. Getting Started – System Components

The CoolLED pE-100 Illumination System is supplied with the following components:

1. LED Light Source.
2. Manual Control Pod.
3. Microscope adaptor for specific microscope model (Direct attachment version only).
4. Liquid light guide (light guide version only).
5. DC Power Supply Type GST25A12-P1J.
6. IEC Power Cable (not shown).
7. User Guide (not shown).

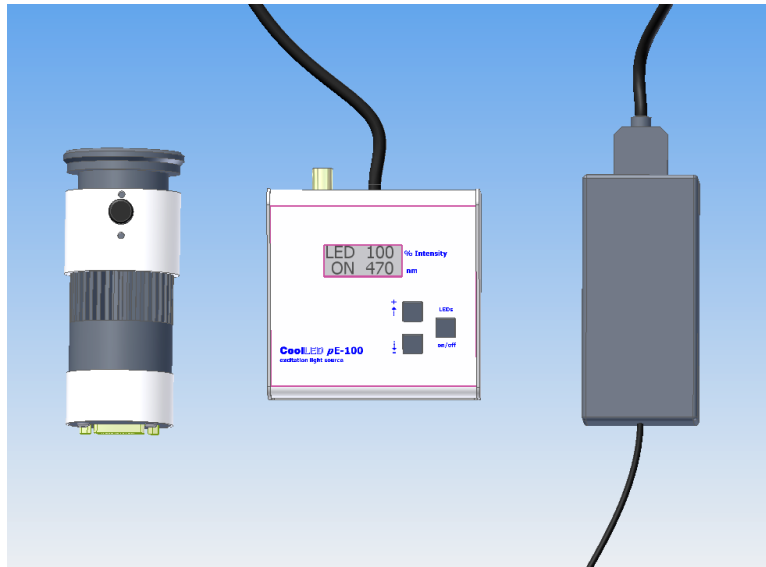

If any components are missing or appear damaged, please contact CoolLED immediately.

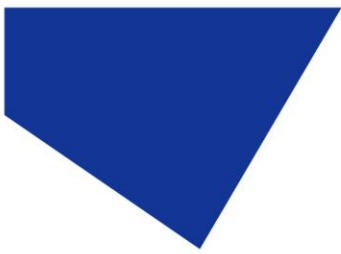

## 4. Installation and Setup

### 4.1.

Carefully unpack the components from the shipping cartons.

### 4.2.

Insert the Control Pod cable into the LED Light Source.



### 4.3.

Connect the power connector from the DC power supply to the Control Pod as shown. Ensure that the DC power supply is the one supplied with the product. Using non CoolLED power supplies may damage the Light Source and will invalidate the warranty. At this stage do not connect the mains power lead to the DC power supply.



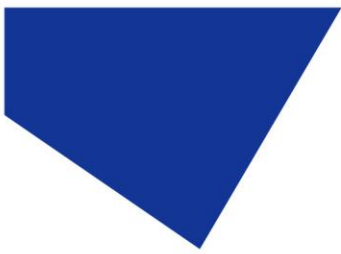

4.4.

Attach the LED Light Source to the epi-fluorescence port on your microscope. Your pE-100 will have been supplied with a compatible fitting for the microscope you specified at order. Attach the Light Source ensuring that it is secure and true/flush with the microscope.

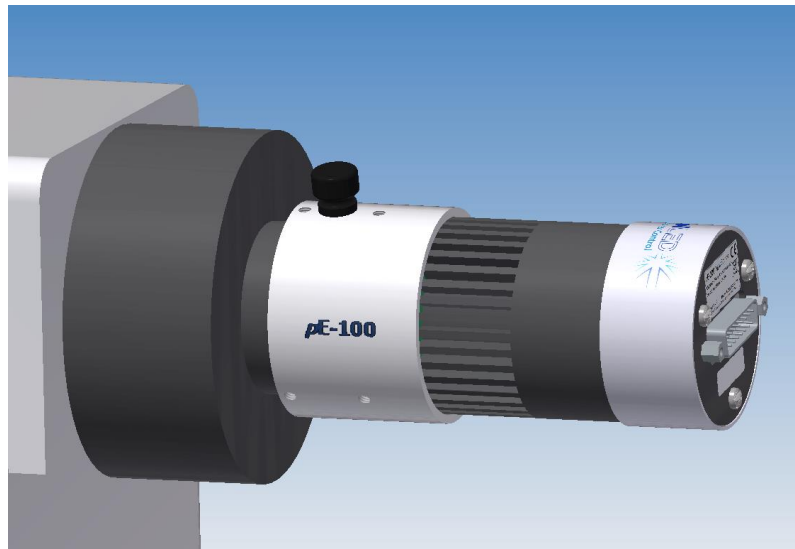

4.5.

Ensure that there is free airflow around the LED Light Source so that the cooling system is not impaired. A gap of 200 mm on either side is sufficient.

4.6.

With the LED Light Source now attached to the microscope it is safe to connect the mains power. Connect the mains lead supplied to a convenient socket, plug in the IEC connector into the DC power supply and switch the power on at the socket.

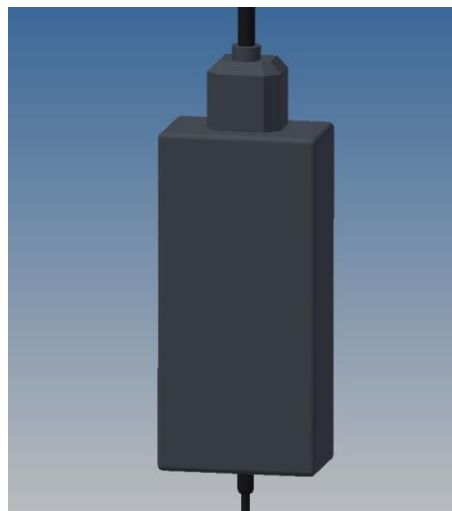



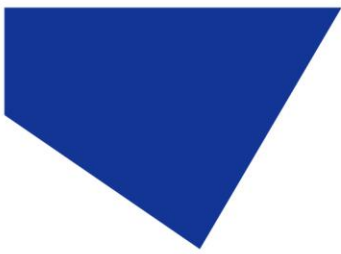

## 5. Operation - Manual Control

### 5.1.

Manual Control Pod Operation on/off.

The pE-100 is easily controlled from the manual Control Pod. LEDs are switched on and off by pressing the 'on/off' button.

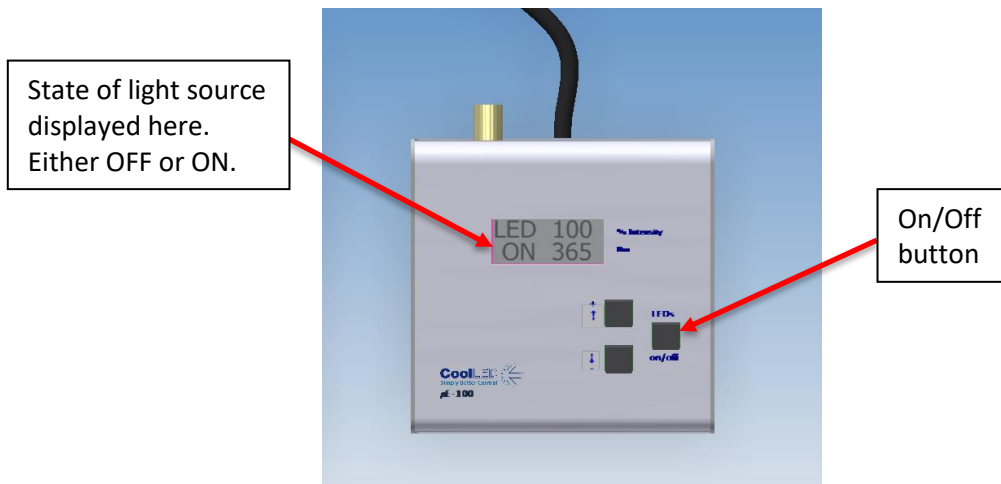

### 5.2.

At start-up the Light Source will revert to the same settings that were set when it was last powered down. New Light Sources are supplied with the settings as shown.

### 5.3.

Adjust the intensity of the Light Source by pressing the up and down intensity buttons. This is displayed in 1 % steps between 20 % and 100 %. Between 0 % and 20 % this figure is displayed in 0.2 % intensity steps.

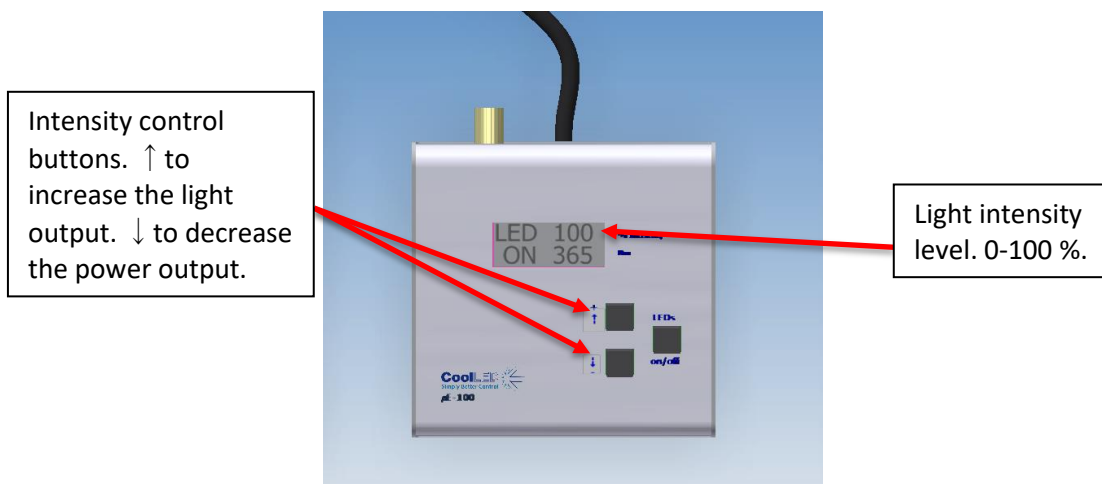

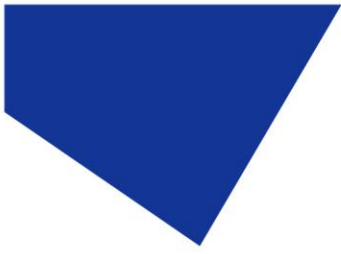

## 6. Remote Operation – TTL

### 6.1.

The pE-100 can be controlled remotely via a TTL signal.

### 6.2.

TTL control uses the single BNC socket on the reverse of the Control Pod.



### 6.3.

The TTL signal controls the on/off function of the Light Source. A TTL 'high' will cause the LEDs to be on, independent of the state of the on/off button. The intensity of the LEDs are manually set on the Control Pod.

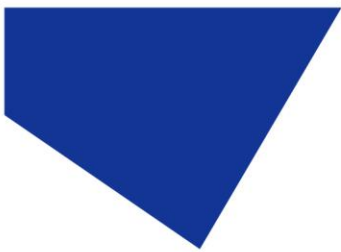

### 6.4.

The TTL input circuit has been designed to maximise the switching speed of the LEDs to give the user precise control of the excitation light reaching the sample.

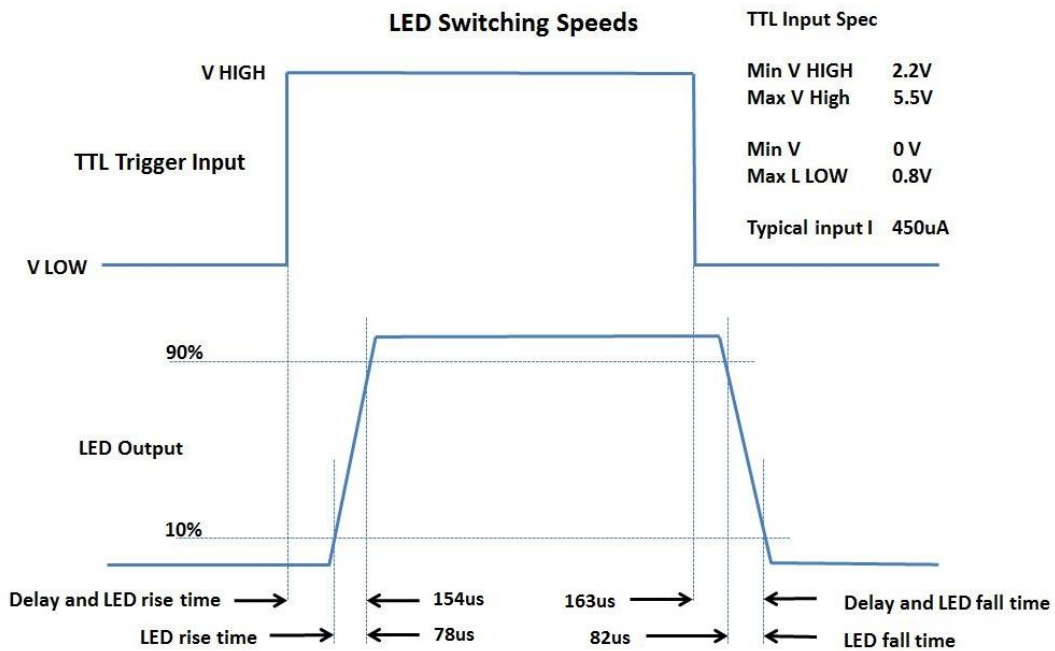

*Note: Switching speeds vary slightly depending on LED wavelength and the intensity that is used.*

### 6.5.

With fast repetitive switching, the Control Pod display will not be able to respond at the same speed and so can get out of synch. If after a train of pulsing, the display on the Control Pod indicates that the LEDs are on while they are actually off, simply press the 'on/off' button to reset the display correctly.

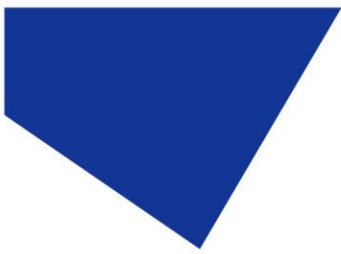

## 7. Optical Setup

### 7.1.

The pE-100 has been designed to work on the majority of fluorescence microscopes, both new and old. As would be expected, there is some variation in the optical path and elements within every microscope. In order to accommodate these variations, the pE-100 is supplied with a small adjustment which allows the user to optimise the performance of the illumination system when it is first fitted. This is a one-time adjustment. No further adjustment will be required during the life of the product unless changes are made to the microscope or the illumination system is fitted to a different microscope (See [Section 10](#) for further information on fitting to a different microscope).

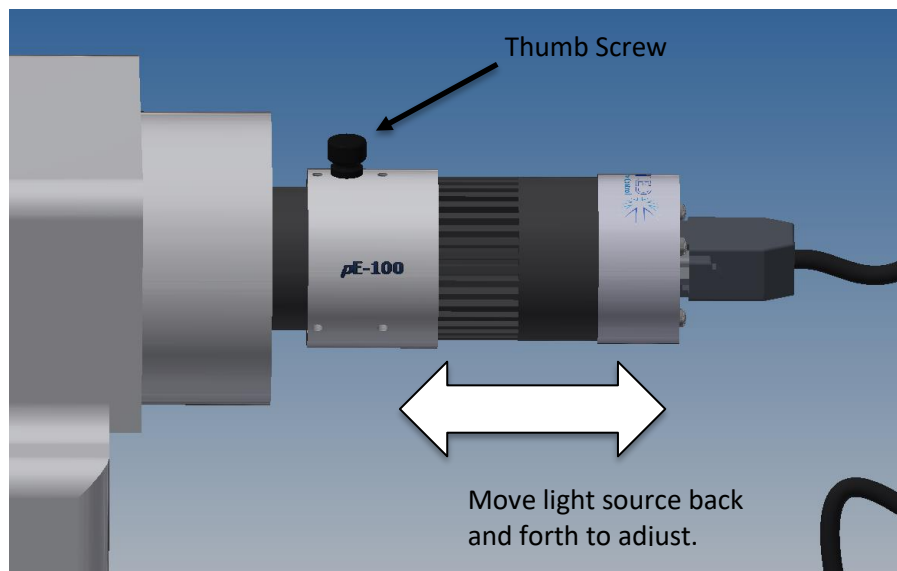

### 7.2.

To make the adjustment, set up a typical sample on the microscope that gives an image over the whole field of view. Loosen the thumbscrew and slide the LED head back and forth until you achieve the maximum brightness with an even field of view. Tighten the thumbscrew to prevent the setting from changing.

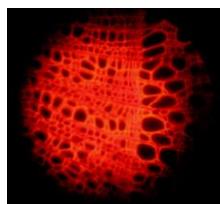

*Light source too far in.*

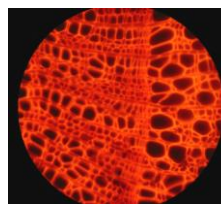

*Light source in optimal position.*

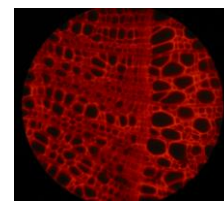

*Light source too far out.*

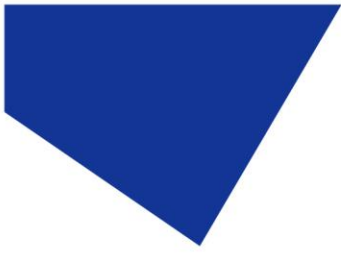

## 8. Settings/Additional Information

### 8.1.

Display Backlight and Contrast settings.

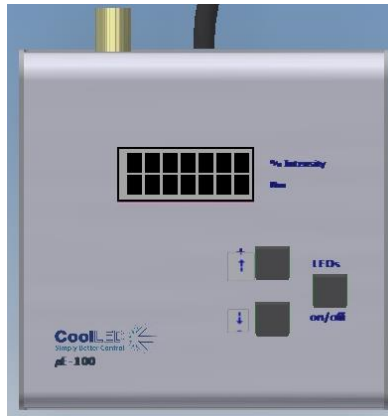

Upon switching on the Control Pod a chequered pattern shall appear on the display. If any button is pressed at this stage, then you shall be taken through a setup sequence.

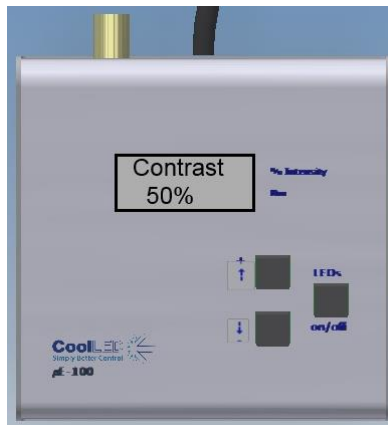

The first option displayed is the contrast adjustment. The contrast setting can be adjusted using the two arrow buttons. This is adjusted in 5 % increments.

After having set the contrast press the On/Off button once to continue.

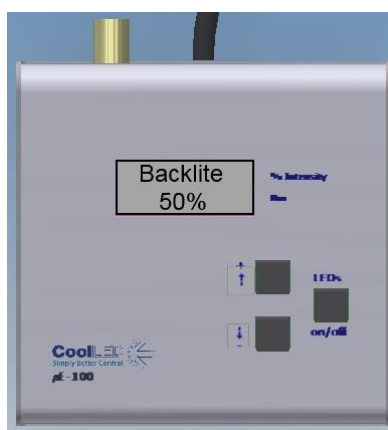

The next screen displayed shall be the Backlight adjustment. The Backlight can be adjusted using the two arrow buttons. This is adjusted in 5 % increments.

After having set the backlight press the On/Off button once to continue.

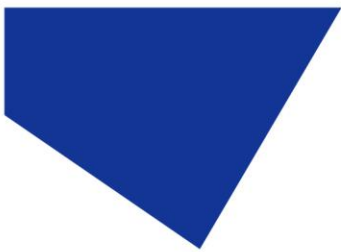

## 8.2.

### System Information



To display the system information, complete the steps described in Section 8.1.

The first screen shown displays the firmware version of the system.

Using the arrow buttons, information will be displayed about the head code, the head temperature, the sink temperature and the sink voltage.

After having viewed the system information press the On/Off button once to continue.

## 8.3.

### LED usage information



The system automatically records the total time that the LEDs are on.

To view this information complete Sections 8.1 & 8.2. The system displays a figure in hours.

Once the LED usage information has been viewed press the On/Off button to continue. This button press will return you to the standard operation display.

## 9. Routine Care and Maintenance

### 9.1.

The pE-100 requires little or no maintenance throughout its life. There are no field serviceable parts so there is no need to remove the covers.

### 9.2.

Cleaning of the external surfaces can be carried out with a mild soap and water solution used to lightly dampen a lint-free cloth. Ensure that no liquid is allowed to enter the product through vents and panel edges. Avoid optical surfaces.

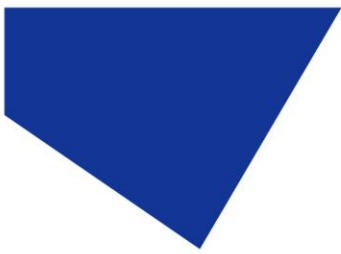

### 9.3.

Cleaning of optical surfaces may be necessary if debris or finger prints accidentally come into contact with the lens during installation. In the first instance remove any loose debris with an air duster (aerosol or rubber blower).

### 9.4.

Fingerprints or other liquid type contaminants should be removed using standard lens cleaning procedures. Do not flood the lens surfaces with fluid as liquid could enter the product and cause damage.

## 10. Fitting the pE-100 to a Different Microscope

### 10.1.

The pE-100 has been designed to be compatible with a wide range of fluorescence microscopes, both new and old. Every microscope manufacturer has one or a number of methods of attaching the fluorescence light source. CoolLED has designed a comprehensive range of adaptors to match these microscopes.

### 10.2.

If you intend to use the pE-100 on a different microscope than the make and/or model that it was originally intended for, please contact CoolLED to check whether the Light Source will be compatible in its current form. We will be able to advise whether an adaptor swap or optical adjustment is required. Please note that even if a microscope accepts the same physical adaptor, the internal optics may differ.

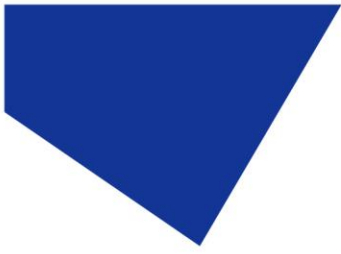

## 11. pE-100 Liquid Light Guide Option

### 11.1.

The pE-100 is available with a 3 mm liquid light guide rather than using a direct attachment adaptor. This enables the Illumination System to be used on microscopes which just have a liquid light guide input, the collimating optics being an integral part of the microscope.



### 11.2.

The liquid light guide is fixed to the Light Source by CoolLED. There is a choice of 1 metre, 1.5 metre or 3 metre light guides that can be fitted. This is to be specified at the time of purchase. The light guide is secured in place and is not swappable by the user.

### 11.3.

Do not bend the liquid light guides through sharp corners. It is recommended to ensure a minimum bend radius of 75 mm. Ensure that the Light Source has a sufficient clearance to ensure adequate airflow for the cooling system.



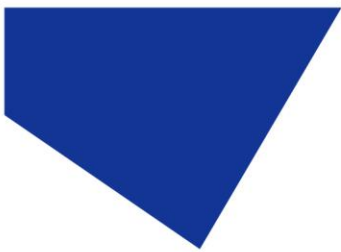

11.4.

The use of a liquid light guide will be attractive for use in electrophysiology as this allows the Light Source to be placed outside the Faraday cage to reduce electrical noise close up to the samples. The pE-Universal Collimator is available for these applications. See [Section 14](#) for details and order codes.

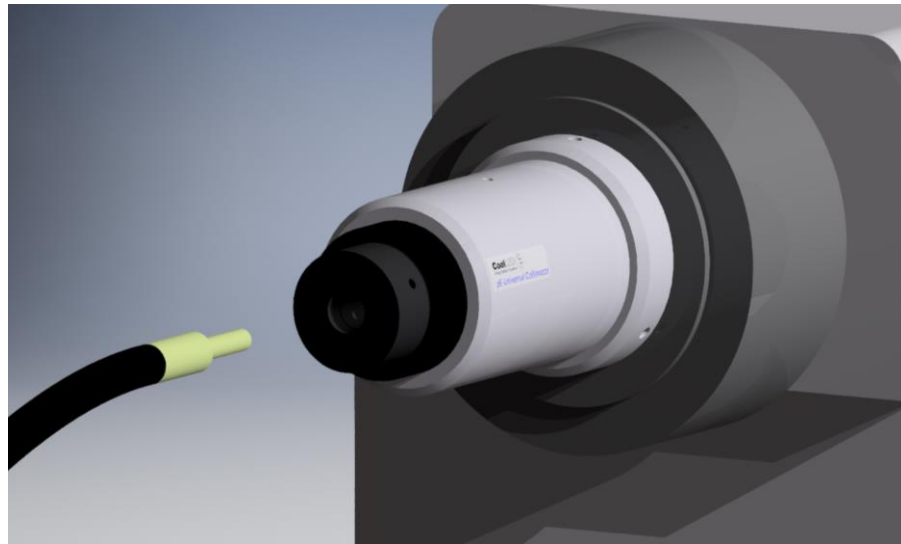

11.5.

When using this collimator, it is important to set up the optics correctly to optimise the performance of the Illumination System. Full setup instructions are given in the separate user manual for the pE-Universal Collimator.

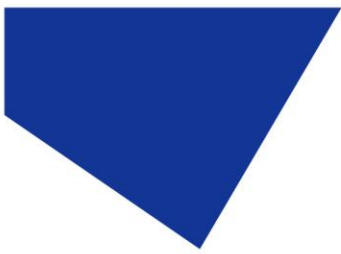

## 12. Product Specifications

### 12.1.

Power requirements  
100-240 V a.c 50/60 Hz 0.7 A

### 12.2.

Power consumption  
Standby mode max 2.2 W  
Full Intensity (100 % setting) max 25 W

### 12.3.

Dimensions:  
Light Source (Direct fit) 60 mm (w) x 170 mm (d) x 70 mm (h)  
-weight 0.38 kg  
Light Source (Light guide version) 52 mm (w) x 95 mm (d) x 52 mm (h)  
-weight 0.38 kg  
Control Pod 102 mm (w) x 110 mm (d) x 50 mm (h)  
- weight 0.55 kg  
Power Supply 55 mm (w) x 95 mm (d) x 40 mm (h)  
- weight 0.19 kg

### 12.4.

Environmental Operating Conditions  
Operating 5 – 35 °C

## 13. Product Options and Order Codes

See website ([Microscope Illuminators | LED Illumination Systems | CoolLED](#))  
for full details of product options and order codes.

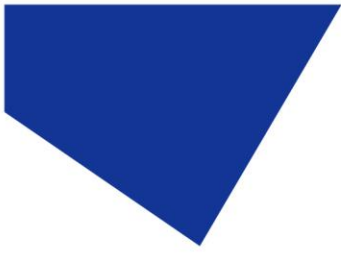

## 14. Warranty and Repairs

Please refer to CoolLED's current Warranty Policy available on our website <https://www.coolled.com/support/coolled-warranty/>. Although warranty terms are fixed at the time of ordering according to the terms and conditions of sale in place, the Warranty Policy may be subject to periodic change so please check to avoid confusion.

For any warranty queries or in the event of the product developing a fault, make contact with [support@coolled.com](mailto:support@coolled.com) for further assistance. You shall be asked to provide your microscope make and model, the product serial number and a brief description of the issue. You shall then be issued with a Support Case to manage your issue.

## 15. Compliance and Environmental

For current compliance statements and environmental information please refer to our website <https://www.coolled.com/support/environment/>

### 15.1. CoolLED's Recycling Program

At CoolLED, we recognize the importance of preserving the global environment. We are proud to provide a Recycling Program that enables CoolLED customers and end-users to send back used CoolLED Light Sources for recycling, free of charge.

Together we can reduce the burden on our environment through responsible disposal and recycling of End-of-Life Light Sources. You can help us by filling in our online contact form and providing us with your contact details and the serial number of the CoolLED Light Source that you wish to return and we will collect it free of charge.

If you are taking delivery of a replacement CoolLED Light Source, why not send the old one back in the packing box of the new one?

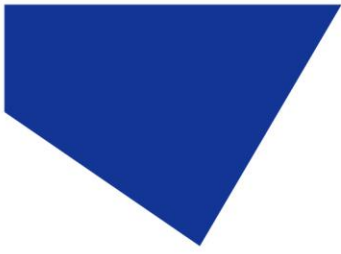

## 16. Contact Details

CoolLED Ltd  
26 Focus Way  
Andover  
Hants  
SP10 5NY  
UK

Phone           +44 (0)1264 323040   (Worldwide)  
                  1-800-877-0128    (USA + Canada)

Email           [info@cooled.com](mailto:info@cooled.com)

Online          [www.cooled.com](http://www.cooled.com)